



## Feature

- Three Phase
- High Attenuation Characteristics (150KHz ~ 1MHz)
- 1-Stage Filter
- Easy Push-Down Terminal Block
- Din Rail Mountable (Option)



### TNS-50 Series (-DIN) Derating Curve

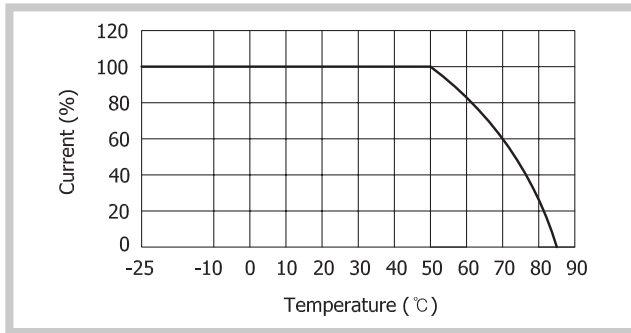

### TNS-50 Series (-DIN) Circuit Diagram

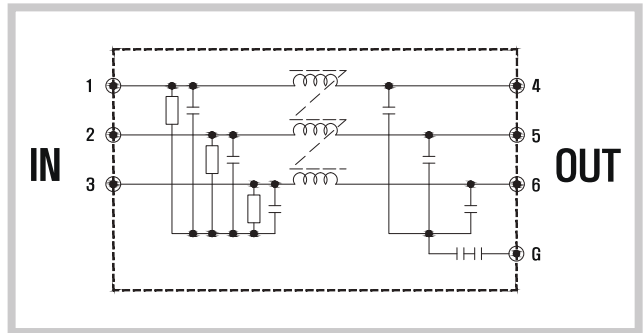

MODEL	Rated Voltage (AC/DC)	Rated Current	Laekage Current (60Hz)	Naximum Air Temperature	Operating Temperature
TNS-5006 (-DIN)	500V MAX	6A	5.0mA Max	50°C Max	-25°C ~+85°C
TNS-5010 (-DIN)	500V MAX	10A	5.0mA Max	50°C Max	-25°C ~+85°C
TNS-5020 (-DIN)	500V MAX	20A	5.0mA Max	50°C Max	-25°C ~+85°C
TNS-5030 (-DIN)	500V MAX	30A	5.0mA Max	50°C Max	-25°C ~+85°C
TNS-5040	500V MAX	40A	5.0mA Max	50°C Max	-25°C ~+85°C
TNS-5050	500V MAX	50A	5.0mA Max	50°C Max	-25°C ~+85°C
TNS-5060	500V MAX	60A	5.0mA Max	50°C Max	-25°C ~+85°C
TNS-50080	500V MAX	80A	5.0mA Max	50°C Max	-25°C ~+85°C
TNS-50100	500V MAX	100A	5.0mA Max	50°C Max	-25°C ~+85°C
TNS-50120	500V MAX	120A	5.0mA Max	50°C Max	-25°C ~+85°C
TNS-50150	500V MAX	150A	5.0mA Max	50°C Max	-25°C ~+85°C
TNS-50200	500V MAX	200A	5.0mA Max	50°C Max	-25°C ~+85°C
TNS-50250	500V MAX	250A	5.0mA Max	50°C Max	-25°C ~+85°C
TNS-50300	500V MAX	300A	5.0mA Max	50°C Max	-25°C ~+85°C
TNS-50400	500V MAX	400A	5.0mA Max	50°C Max	-25°C ~+85°C
TNS-50500	500V MAX	500A	5.0mA Max	50°C Max	-25°C ~+85°C
TNS-50600	500V MAX	600A	5.0mA Max	50°C Max	-25°C ~+85°C
TNS-50700	500V MAX	700A	5.0mA Max	50°C Max	-25°C ~+85°C

## Attenuation Characteristics

TNS-2006, 5006 (-DIN)

TNS-2010, 5010 (-DIN)

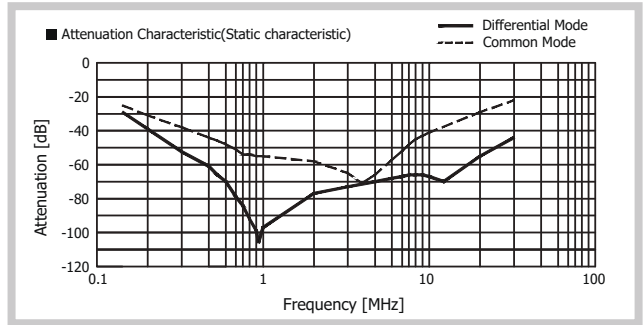
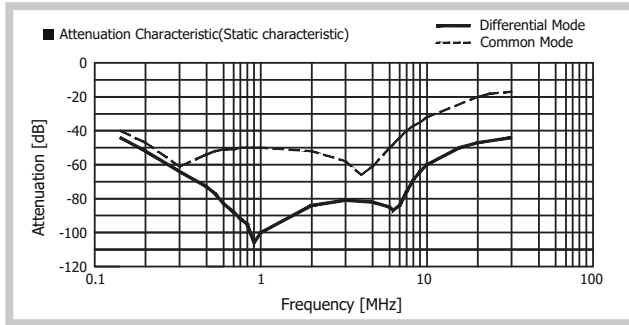

TNS-2020, 5020 (-DIN)

TNS-2030, 5030 (-DIN)

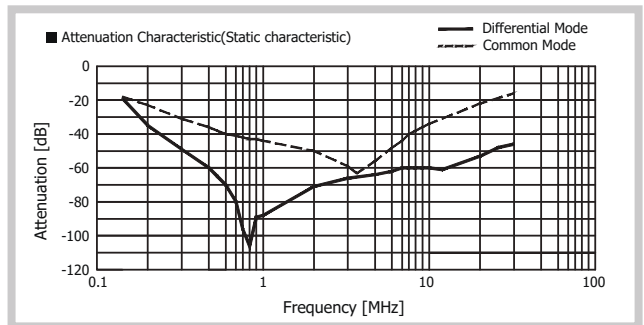
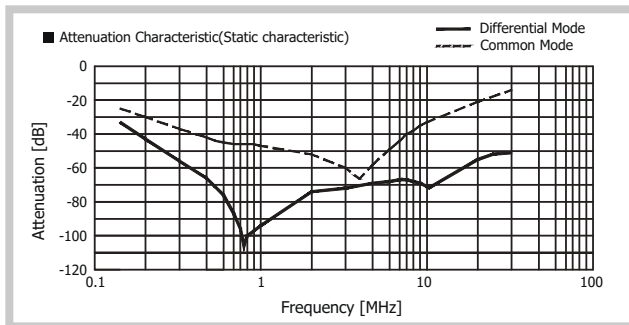

TNS-2040, 5040

TNS-2050, 5050

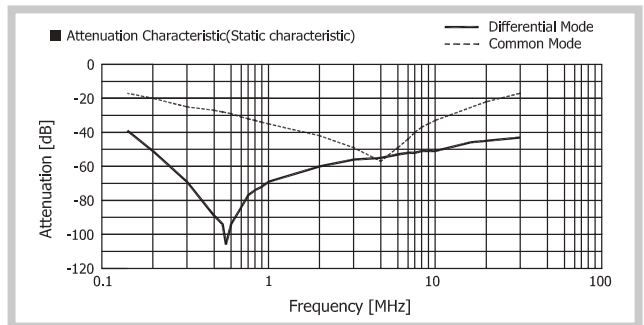
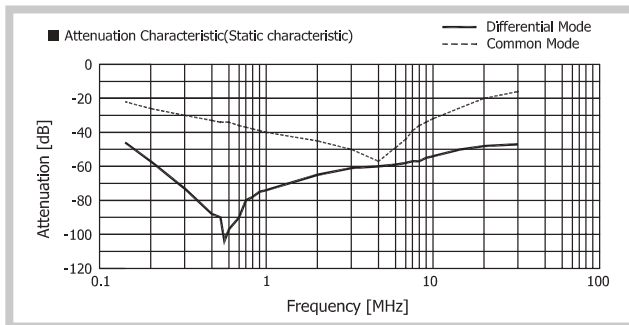

TNS-2060, 5060

TNS-20080, 50080

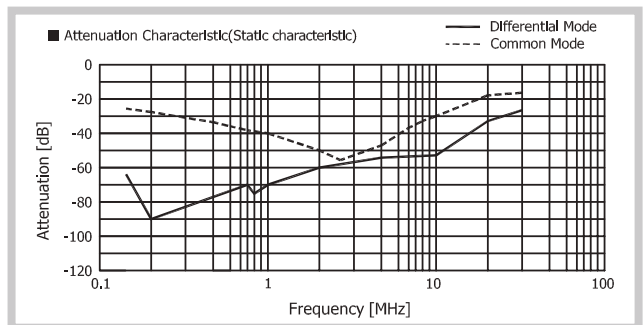
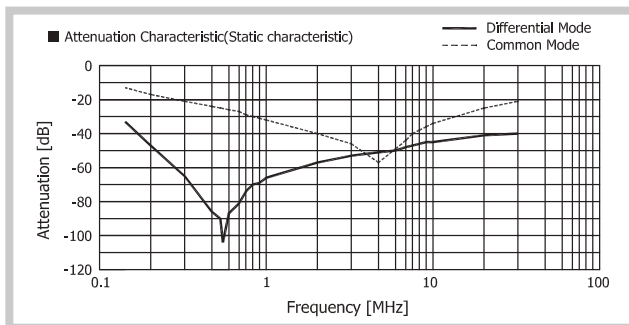

## Attenuation Characteristics

TNS-20100, 50100

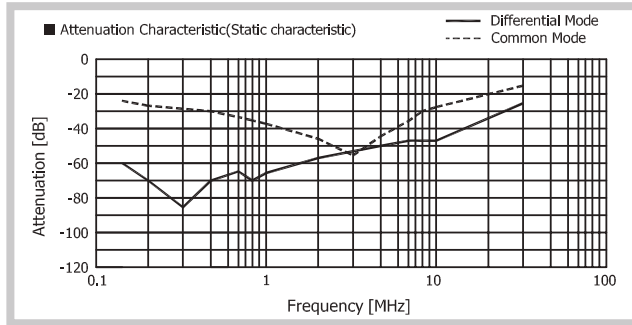

TNS-20120, 50120

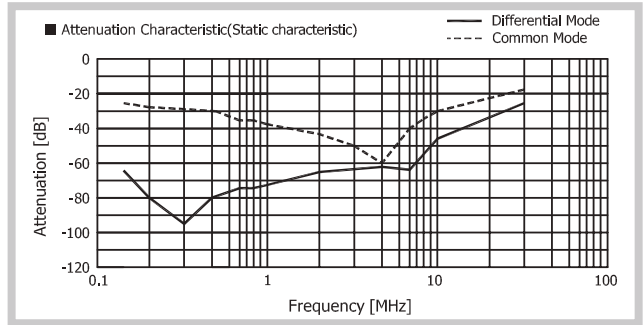

TNS-20150, 50150

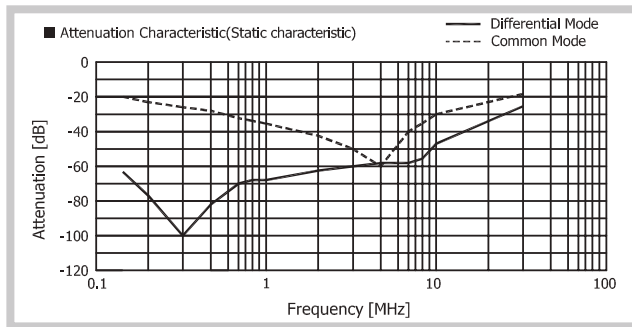

TNS-20200, 50200

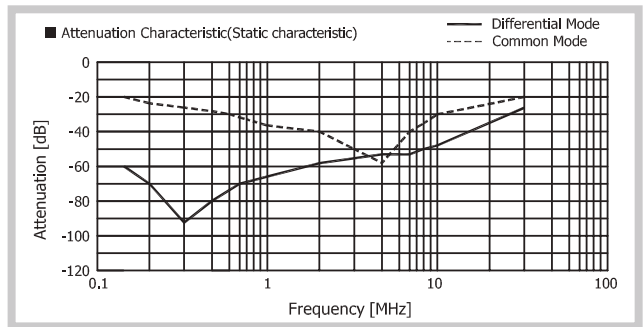

TNS-20250, 50250

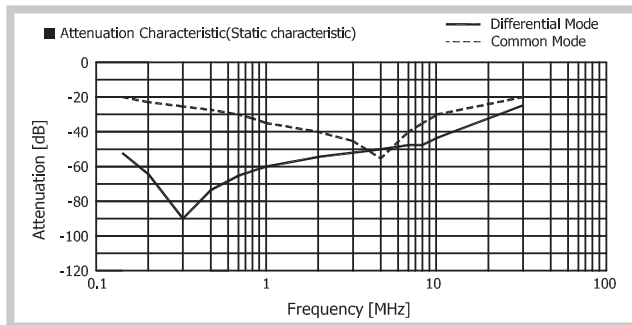

TNS-20300, 50300

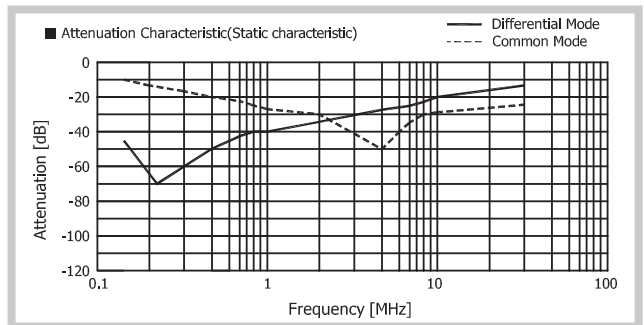

TNS-20400, 50400

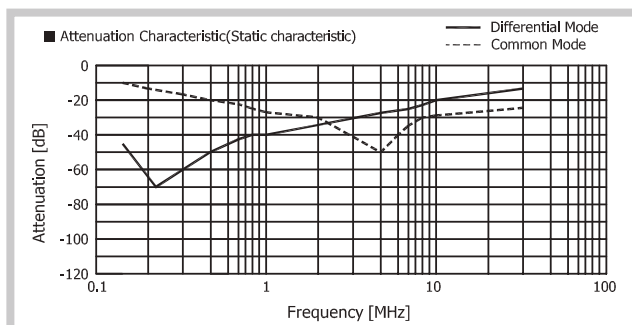

TNS-20500, 50500

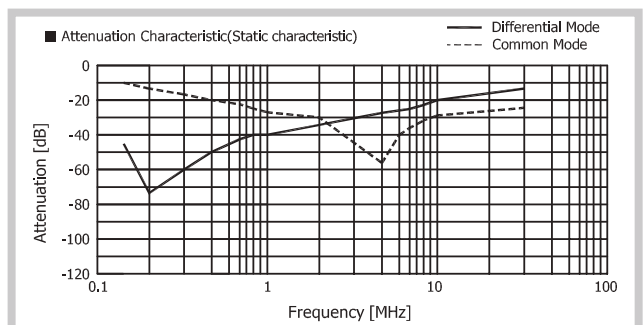

## Attenuation Characteristics

TNS-20600, 50600

TNS-20700, 50700

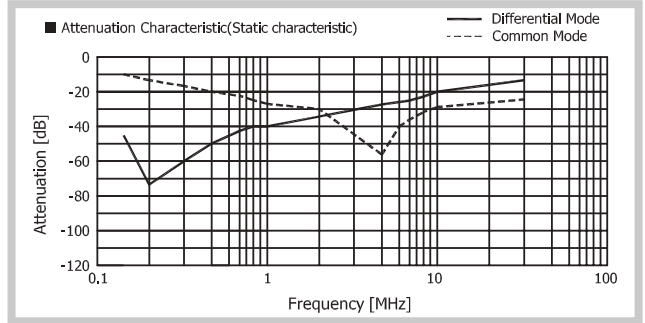
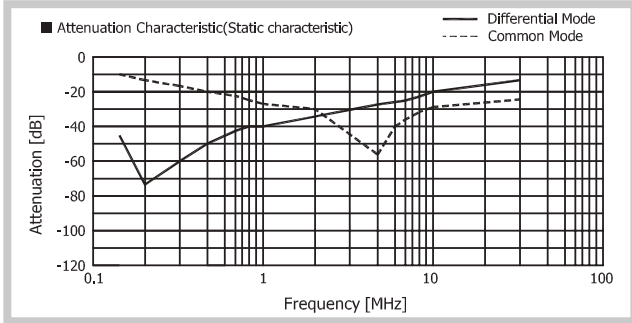

TNS 2006  
2010  
5006  
5010

Dimension

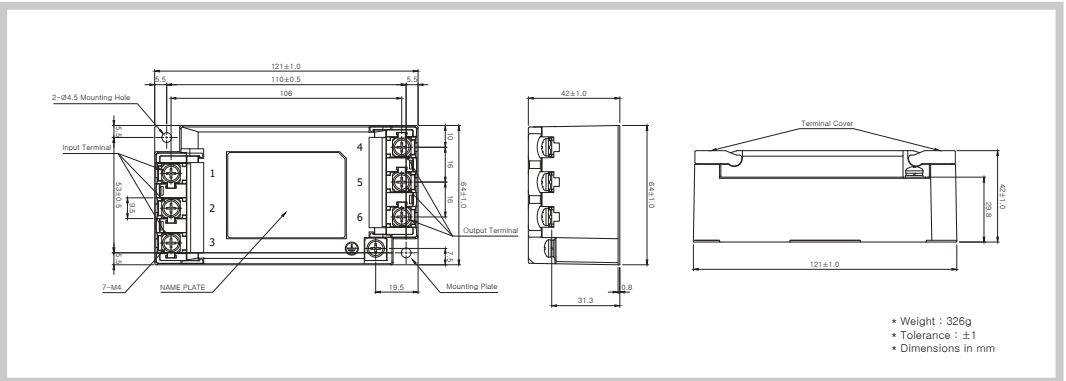

TNS 2020  
2030  
5020  
5030

Dimension

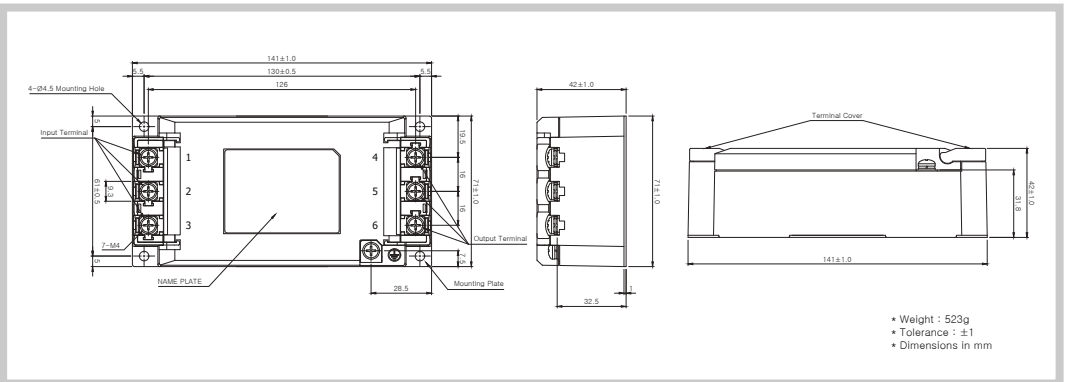

TNS 2040  
2050  
2060  
5040  
5050  
**5060**

Dimension

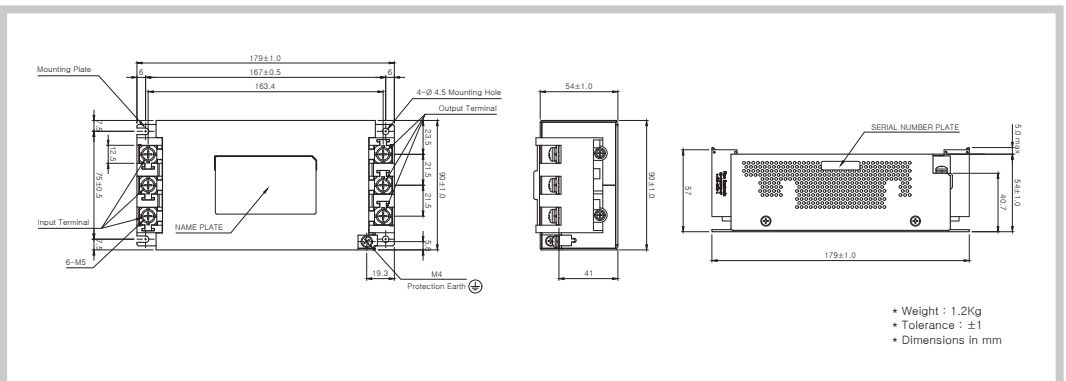

TNS 20080  
20100  
50080  
50100

Dimension

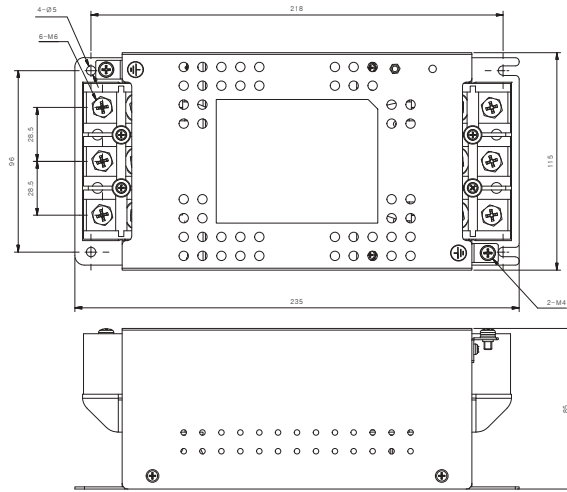

TNS 20120  
20150  
20200  
20250  
50120  
50150  
50200  
50250

Dimension

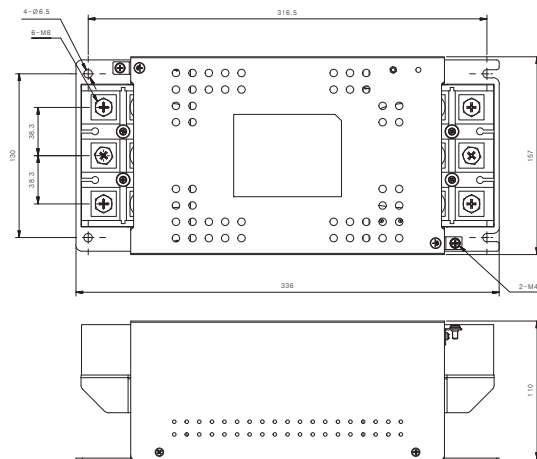

TNS 20300  
20400  
20500  
20600  
20700  
50300  
50400  
50500  
50600  
50700

Dimension

